



 Space Research Industries





THERMOCOAX

SPACE

IN-house
production of MI cable

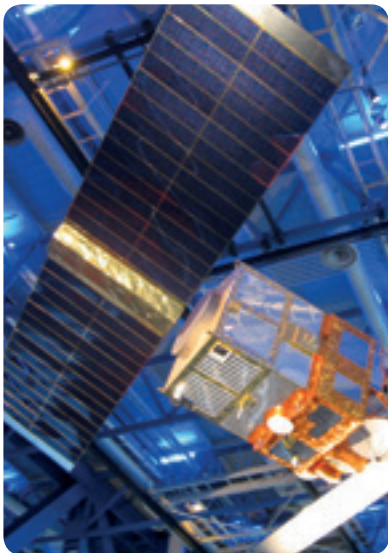

References

➤ **ELECTRICAL PROPULSION:**

- ▣ HELIOS, Spot, Smart 1, Alphasat, Alphabus

➤ **GREEN PROPELLANT THRUSTER**

- ▣ Prisma HPGP, google skybox

➤ **HEAT PIPE SYSTEM**

ARABSAT , Hotbird, Skynet

➤ **HEATING APPLICATIONS:**

Cassini Probe, Venus satellite, Curiosity Rover

➤ **HYDRAZINE PROPULSION:**

- ▣ Pleiades, Spirale, ELISA, SSOT
- ▣ Alsat, Astroterra, Sentinel-2, Galileo, MUSIS, Myriade

➤ **THERMOCOUPLE APPLICATIONS:**

- ▣ ATV module
- ▣ Material Space Laboratory on ISS
- ▣ Vulcain Engine

Our capabilities

Our mission is to develop complete thermal solutions, through advance innovation : from conception to prototype development, all the way through to production.

Our custom thermal systems provide cleaner, cost effective and safer solutions :

- 3D Design / thermal modeling
- From cryogenic temperatures up to 1000°C
- Suitable for atmosphere to UHV environment
- Thermal modeling / simulation
- Experience in common and special alloys (tungsten, aluminum, titanium...)
- Product support & engineering
- Prototypes
- Production manufacturing
- From small up to large size devices
- Research & testing services

The industry's
most trusted
Mineral
Insulated
Cable

- True cold end heater (no connector on the cold/hot junction)
- Minimum bending radius : 3 X Outer Diameter
- High thermal flux > 6 W/cm²
- High dielectric withstand with an insulation resistance 10.13Ω.m at room temperature
- Small size heaters 0.5 mm OD available

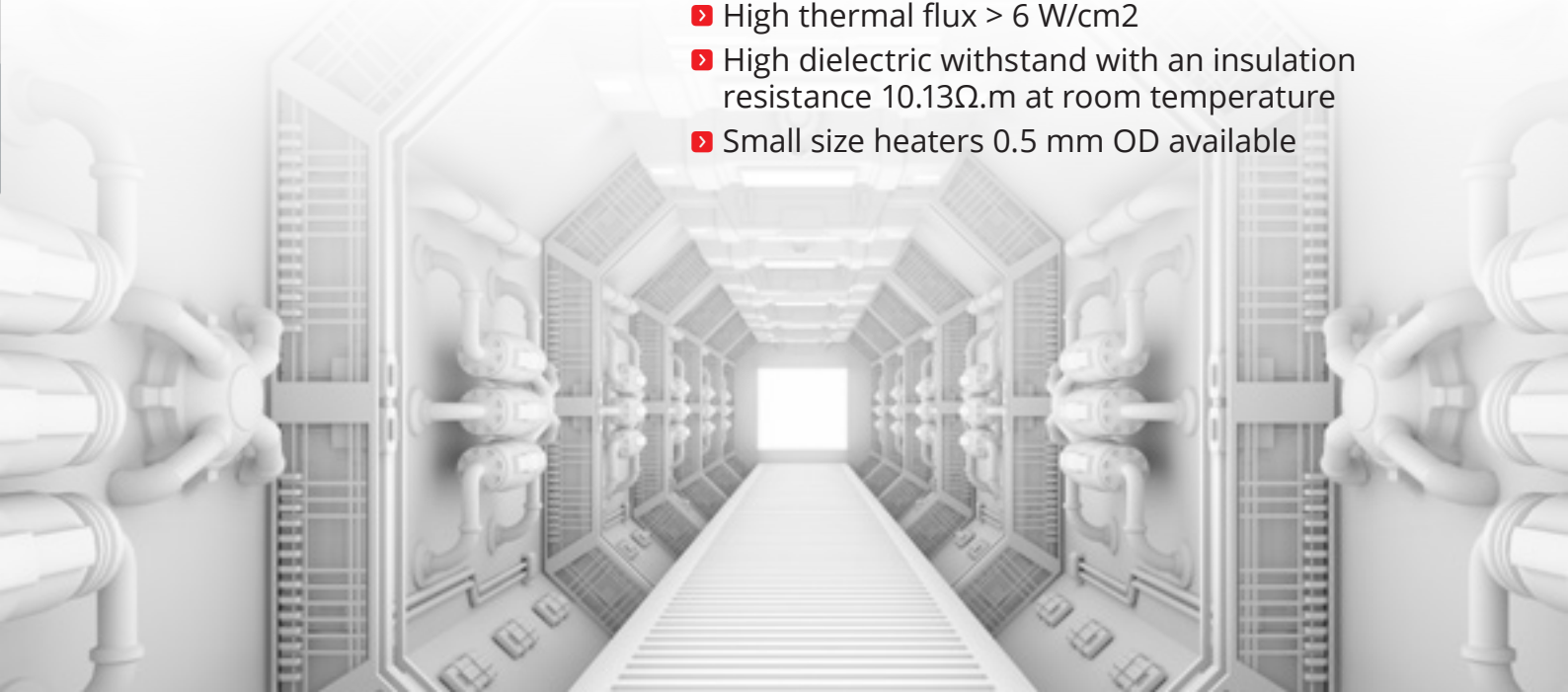

Catalyst Bed Heater FOR CHEMICAL THRUSTERS

Heating system to pre-heat the reactor (thruster) to enable the propellant decomposition

Hydrazine or Green Propellant (ADN)

THERMOCOAX offers 2 designs



Coiled Heater Design

- ▶ Heating cable willed around catalyst
- ▶ 6 and 10 W
- ▶ Other power adjustable
- ▶ 2 heating loops for redundancy
- ▶ Withstanding 1 000°C



Cartridge Design

- ▶ 3 and 3.5 W under 28 V
- ▶ 2 heating loops for redundancy
- ▶ Weight : 35 gr
- ▶ Withstanding 1 000°C



DESIGN FOR A 15 YEAR SPACE MISSION



- ▶ Thrust power from 0.1 up to 250 Newton
- ▶ Heat power: 3, 3.2, 6 and 10 W
- ▶ Voltage 28 V
- ▶ Maxi voltage 37 V
- ▶ Dielectric and insulation resistance under 500 V
- ▶ TML < 1%
- ▶ CVCM < 0.1%
- ▶ ESA Certified

Electrical Thruster

Hall Effect engine

THERMOCOAX magnetic coils accelerate the ions (i.e. Xenon) and drive the engine's thrust.

THERMOCOAX offers the cable or the complete assembly coil ready to be used.

This technology is space qualified and has proven its efficiency and excellent behavior during the space missions.

The Mineral Insulated Cable is the solution for a good behavior in vacuum and high temperature exposition.

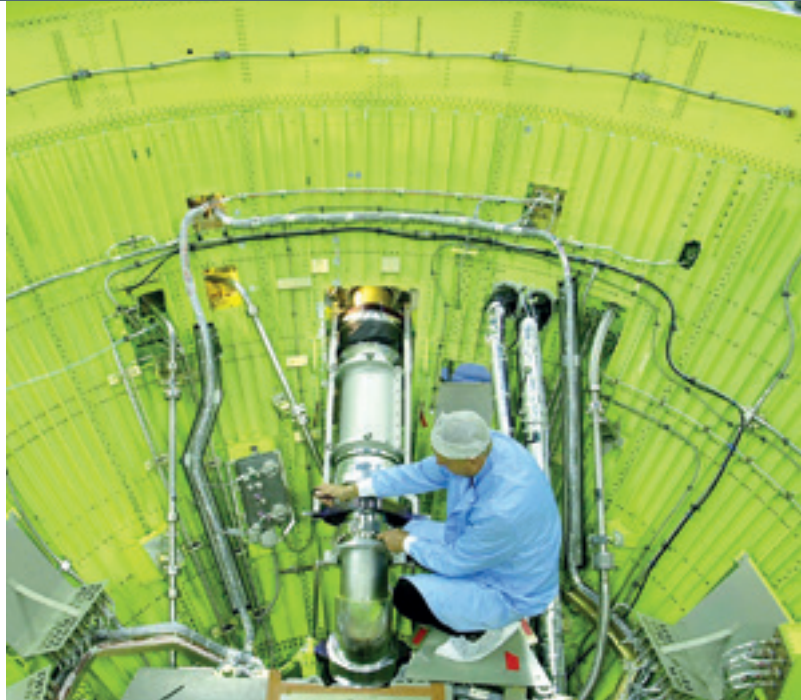

**INCREASE RATIO
PERFORMANCE / COST**

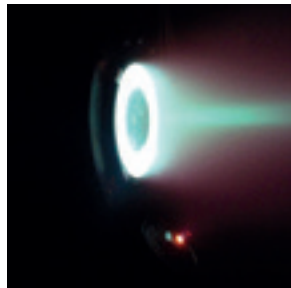

Experience on 92 and 200 mN thrust

- ▶ Inner magnetic coil
- ▶ 4 outer magnetic coils
- ▶ 600°C max
- ▶ Cable Ø 1.9 mm
- ▶ Copper conductor: Ø 1.31mm

- ▶ Partial Discharge Tests : 500 VAC, 1 min, 1 MHz
- ▶ Maxi voltage : 350 V
- ▶ Discharge current : up to 5 Amp
- ▶ Dielectric and insulation resistance under 500 V
- ▶ TML < 1%
- ▶ CVCM < 0.1%
- ▶ ESA Certified



Heat pipe

**For the thermal control of the satellite.
Sun exposition gets very hot and shadow
gets very cold.**

THERMOCOAX heating system is designed for thermal active control and heat cold satellite areas.

- ▶ The cables batches are qualified LAT space standard
- ▶ Light weight and easy integration
- ▶ Standard design
- ▶ Heating power up to 150 W under 100 V
- ▶ Power density 6 W/cm²
- ▶ Other heating power and voltage available
- ▶ Cable Ø down to 1 mm
- ▶ Partial Discharge : 200 and 500 VAC
- ▶ Dielectric and insulation resistance under 500 V
- ▶ TML < 1%
- ▶ CVCN < 0.1%

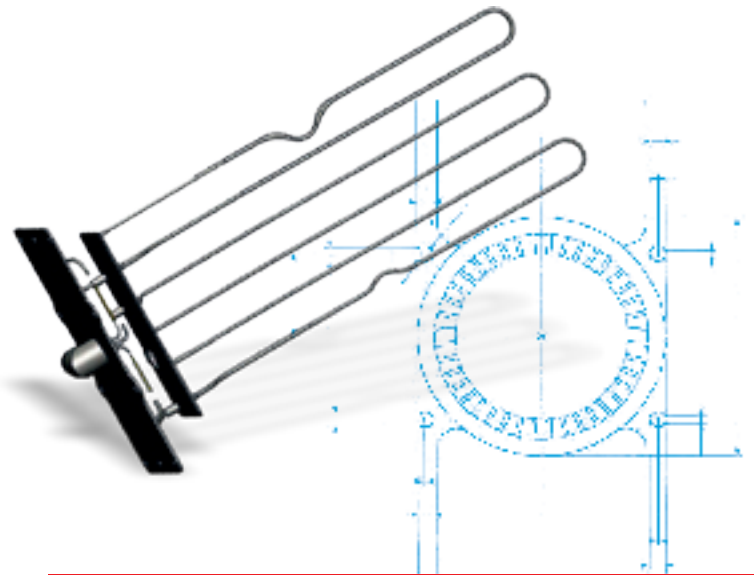

SECURE DATA DURING ANALYSIS



Heating system **FOR MULTISPECTRAL CAMERA**

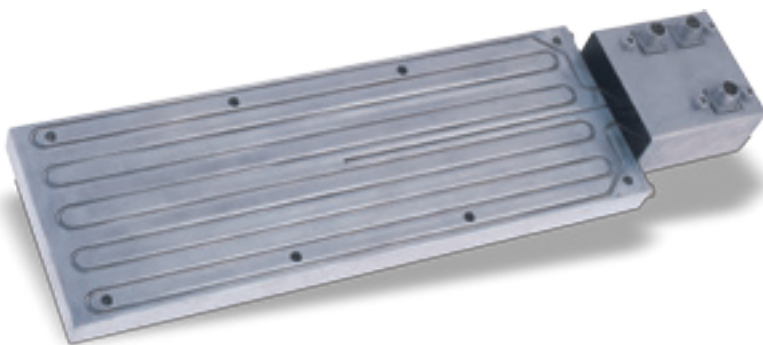

- ▶ Redundancy loops
- ▶ Temperature operation +10 up to +50°C
- ▶ Temperature Survival range : -30 up to +60°C
- ▶ Operating voltage 25 to 50 VDC
- ▶ From 10 to 100 W dissipate
- ▶ Cylinder internal parts black anodized
- ▶ Homogeneity ±2°C

Temperature

THERMOCOAX manufactures its own thermocouple cables. We guarantee high product quality and traceability for our customer

- ▶ From cryogenic temperatures up to 2300°C
- ▶ THERMOCOAX proposes the whole range of thermocouples: T, E, J, K, N, S, R, B, D and C type.
- ▶ Our in-house manufacturing workshops allows THERMOCOAX to adapt the cable construction, i.e. the use of special insulator which meet the particular requirements for high temperature
- ▶ From 0.25 up to 5 mm OD
- ▶ Special junction on extension cable dedicated to space environment
- ▶ Solution for harsh environment as graphite...

THERMOCOAX has its own calibration laboratory and is in conformity with NIST standards.

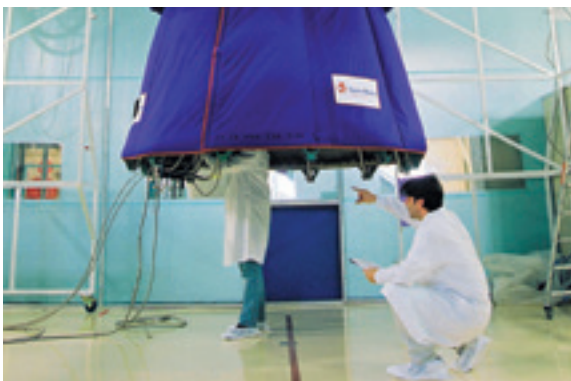

- ▶ **Vibrations Resistant**
- ▶ **Shock resistance**
- ▶ **Hermetically sealed**
- ▶ **Design for minimum 15 years**
- ▶ **Space Mission**

- ▶ Insulation $10^{12} \Omega^*$ meter at room temperature
- ▶ Calibration in accordance with NIST
- ▶ TML < 1%
- ▶ CVCM < 0.1%



EXPAND END USER APPLICATION BASE

Concept, design and computing model techniques (CMT) to simulate the prototype working performances

Inhouse testing and calibration using COFRAC certified laboratory

R&D department for static and dynamic thermal modeling





OUR COMPANY

With nearly 60 years of experience in heating solutions and temperature measurement, THERMOCOAX has acquired a great deal of skill and expertise. THERMOCOAX products are widely used and endorsed in many industries where the highest quality and utmost reliability are essential. All our mineral insulated cables are manufactured in-house with our proprietary and unique procedures.



sales@thermocoax-space.com
www.thermocoax-space.com

YOUR CONTACT

FRANCE :

THERMOCOAX SAS
 40 Bd Henri Sellier
 F 92156 SURESNES Cedex
 Tel.: +33 1 41 38 80 50
 Fax: +33 1 41 38 80 70
info@thermocoax.com

GERMANY

THERMOCOAX ISOPAD GmbH
 Englerstrasse 11
 D-69 126 HEIDELBERG
 Tel.: +49 6221 3043-0
 Fax: +49 6221 3043-956
Isopad.info@thermocoax.com

USA

THERMOCOAX Inc.
 6825 Shiloh Road East,
 Ste B-3
 ALPHARETTA, GA 30005
 Tel.: +1 678 947 5510
 Fax: +1 678 947 4450
info@thermocoax.us

UK

Tel.: +44 (0)7738 437806
info-uk@thermocoax.com

CHINA

Tel.: 13701325459
info-china@thermocoax.com



Thermocouples
 & Heating Elements
 ATEX
 certified and notified

